

# Metal Parts

## 1) Elstein Housings



EBO/100



EBO/75



EBO/50



EBO/25

Further Elstein housings  
(without picture):

EBO/125

## 2) Elstein Reflectors



REO/250



REO/125

## 3) Elstein Mounting profiles



MPO



MPO/2

## 4) Elstein Mounting sheets



MBO/500



MBO/375



MBO/250

## 5) Elstein mounting set



Slide (upper part)



Mounting spring (lower part)

## 6) Elstein fixing spring



Figure 95: Metal accessories

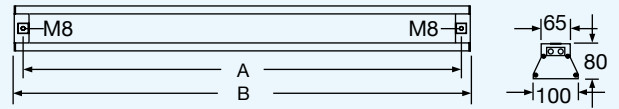

	A	B
EBO/125	1217	1260
EBO/100	967	1010
EBO/75	717	760
EBO/50	467	510
EBO/25	217	260

Other lengths available on request  
(from 125 mm to 2500 mm and longer)

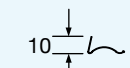
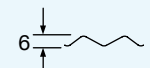
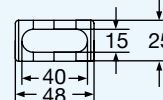
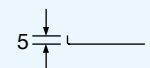
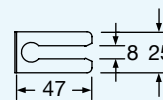
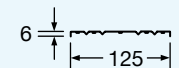
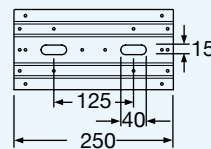
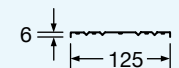
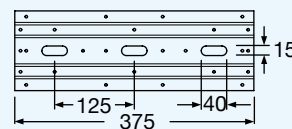
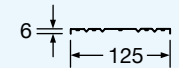
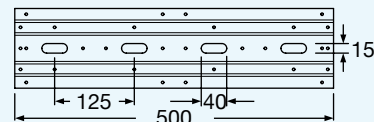
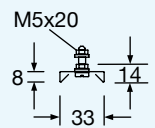
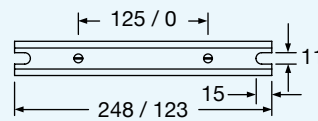
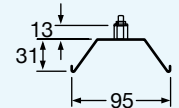
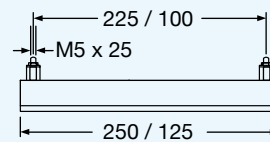

Figure 96: Metal accessories, Dimensions in mm

## 1) Elstein EBO housings

The EBO housings consist of an anodised, extruded aluminium section with an H-like cross-section, on which an aluminium capping section and two aluminium die cast end pieces are fitted.

Each die cast end piece contains a sliding nut with M8 thread for fixing the housings, for example on a steel section frame. They also contain a ceramic bushing for the electricity cables and a labelled safety earth terminal.

The EBO housings are available in the lengths 250 mm, 500 mm, 750 mm, 1000 mm and 1250 mm. Other sizes beginning from 125 mm length are also possible.

EBO housings being equipped with Elstein radiators are available as ready-for-assembly construction elements by using the designation EBF (see there).

## 2) Elstein REO reflectors

The REO/250 and REO/125 reflectors are used to hold and fix the FSM, FSR, HFS/1, HSR/1, HTS/1, SHTS/1, and FSM/2, FSR/2, HFS/2, HSR/2, HTS/2 and SHTS/2 ceramic infrared radiators, and to reflect the IR radiation in the direction of the material to be heated.

They are made from polished stainless steel and have a protective foil on the inside, which must be removed before installation.

REO reflectors are part of the ready to fit EBF construction elements and the fitted REF construction sets.

They are available in the two lengths 125 mm and 250 mm.

## 3) Elstein MPO mounting profiles

The MPO mounting profiles are made from stainless steel and are used to hold and fix HLS and IRS series radiators.

They are available in the two lengths 125 mm and 250 mm.

## 4) Elstein MBO mounting sheets

The MBO mounting sheets are designed for holding and fixing ceramic infrared radiators with the dimensions 122 mm x 122 mm.

They are made from stainless steel and have a protective foil on the upper side which must be removed before installation.

MBO mounting sheets are part of the ready to fit BSI construction panels and are available in the lengths 250 mm, 375 mm and 500 mm.

## 5) Elstein mounting set

All ceramic infrared radiators, which have a standard Elstein socket are fixed to the reflector or mounting sheet with the help of the mounting set.

The mounting set includes a wave mounting spring and a slide, both made from stainless steel.

The scope of delivery of the radiators with a standard Elstein socket includes one mounting set for each radiator.

## 6) Elstein fixing springs

The fixing springs are made from stainless steel and are used to fix HLS and IRS series radiators to the MPO and MPO/2 mounting profiles.

Two springs per radiator are included in the scope of supply of HLS and IRS series radiators.

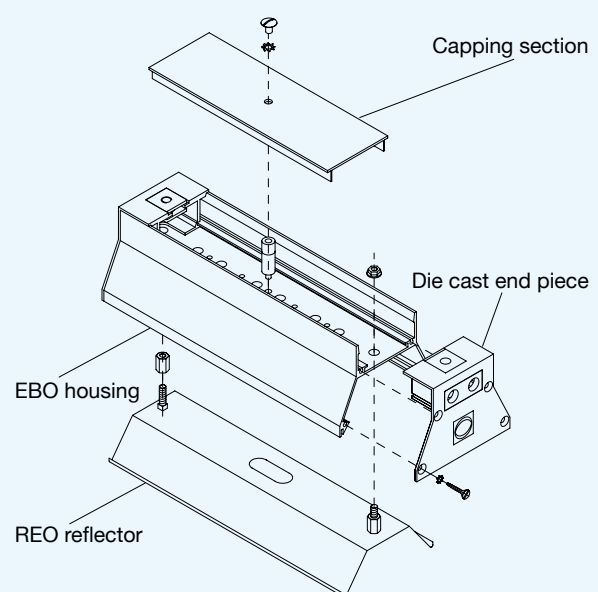

Figure 97: Example for the arrangement of metal parts using an EBO housing with REO reflector